

Engine Control <2GR-FE>

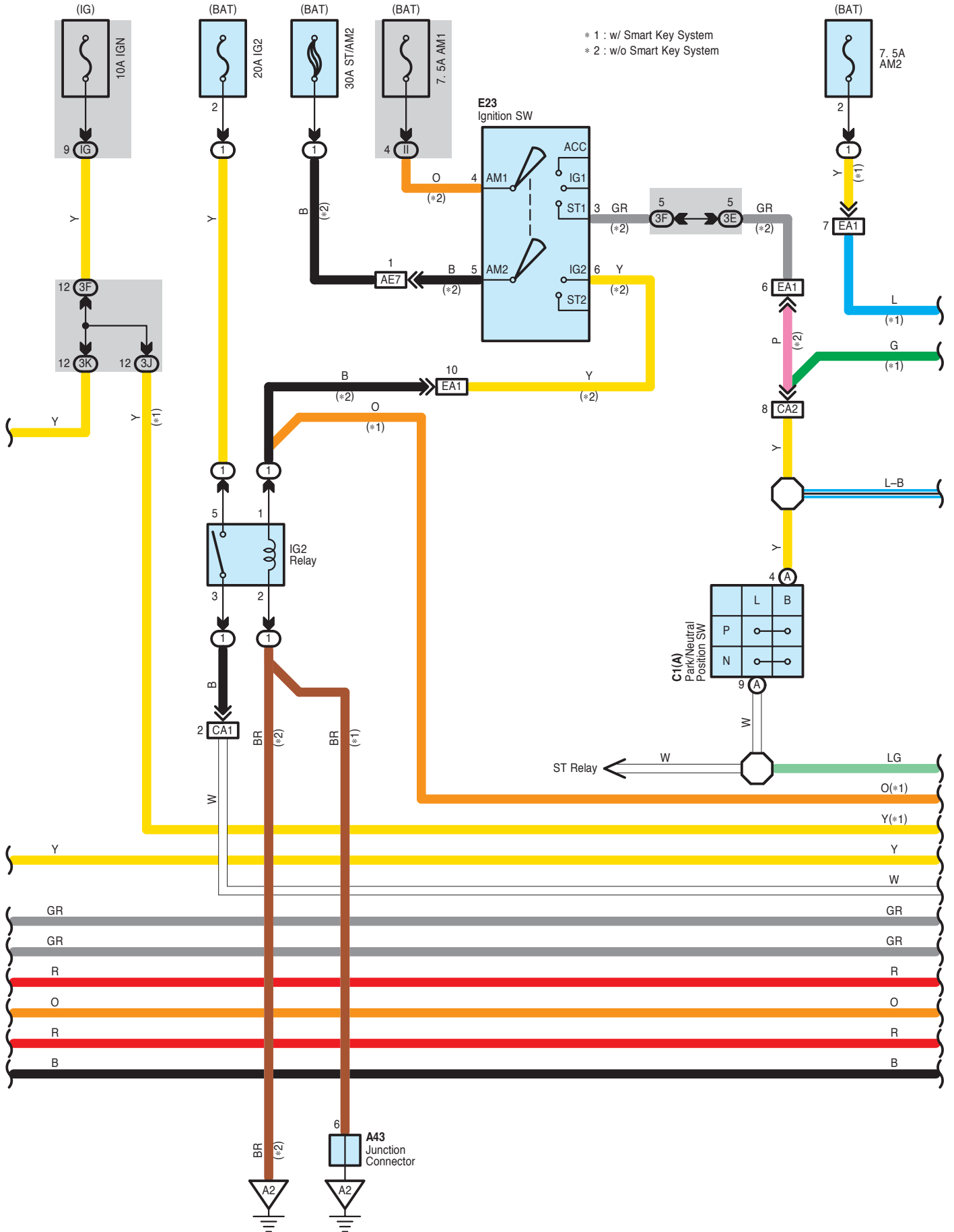

* 1 : w/ Smart Key System
 * 2 : w/o Smart Key System

E6(A), E7(B), E8(C), E9(D)
Main Body ECU

* 1 : w/ Smart Key System

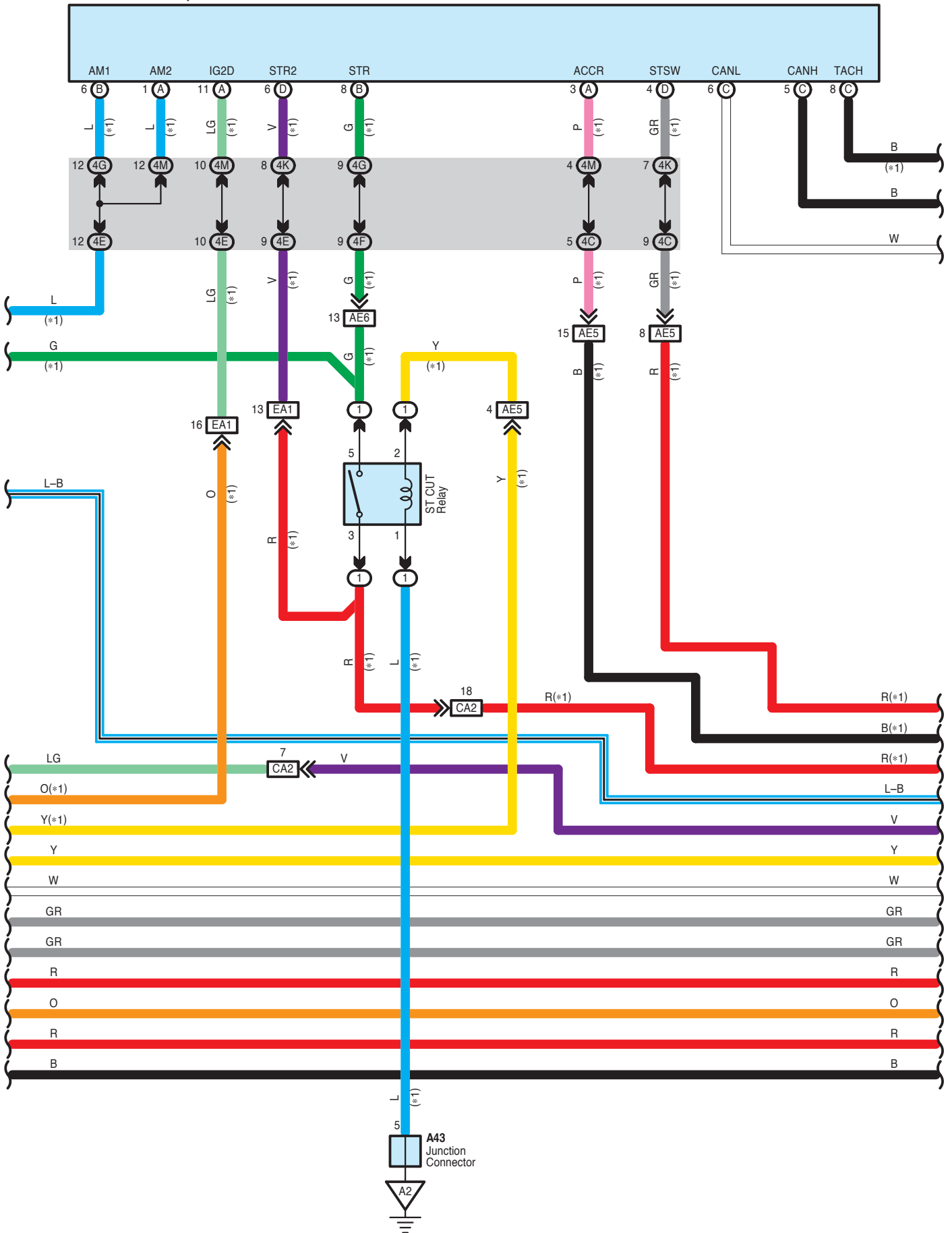

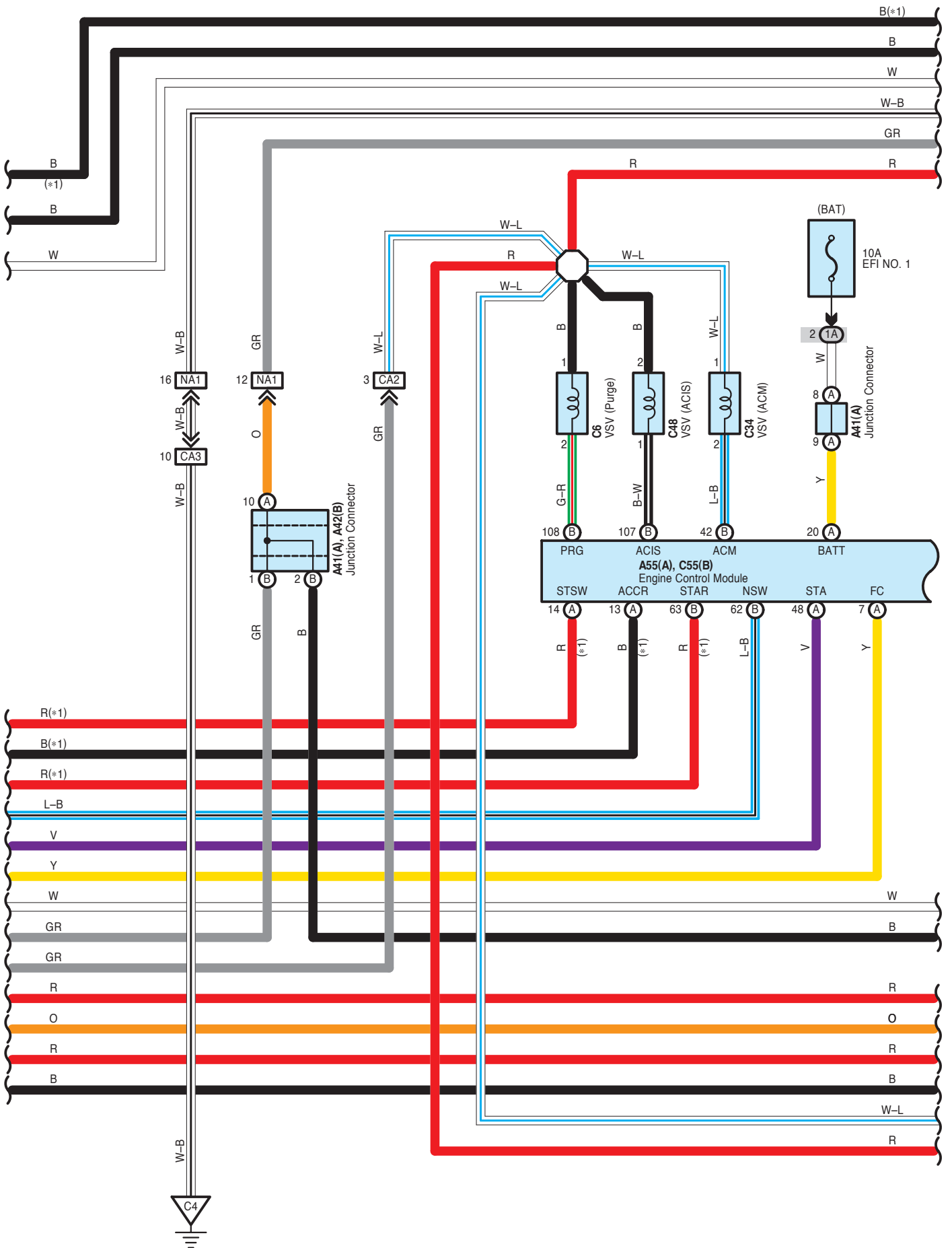

Engine Control <2GR-FE>

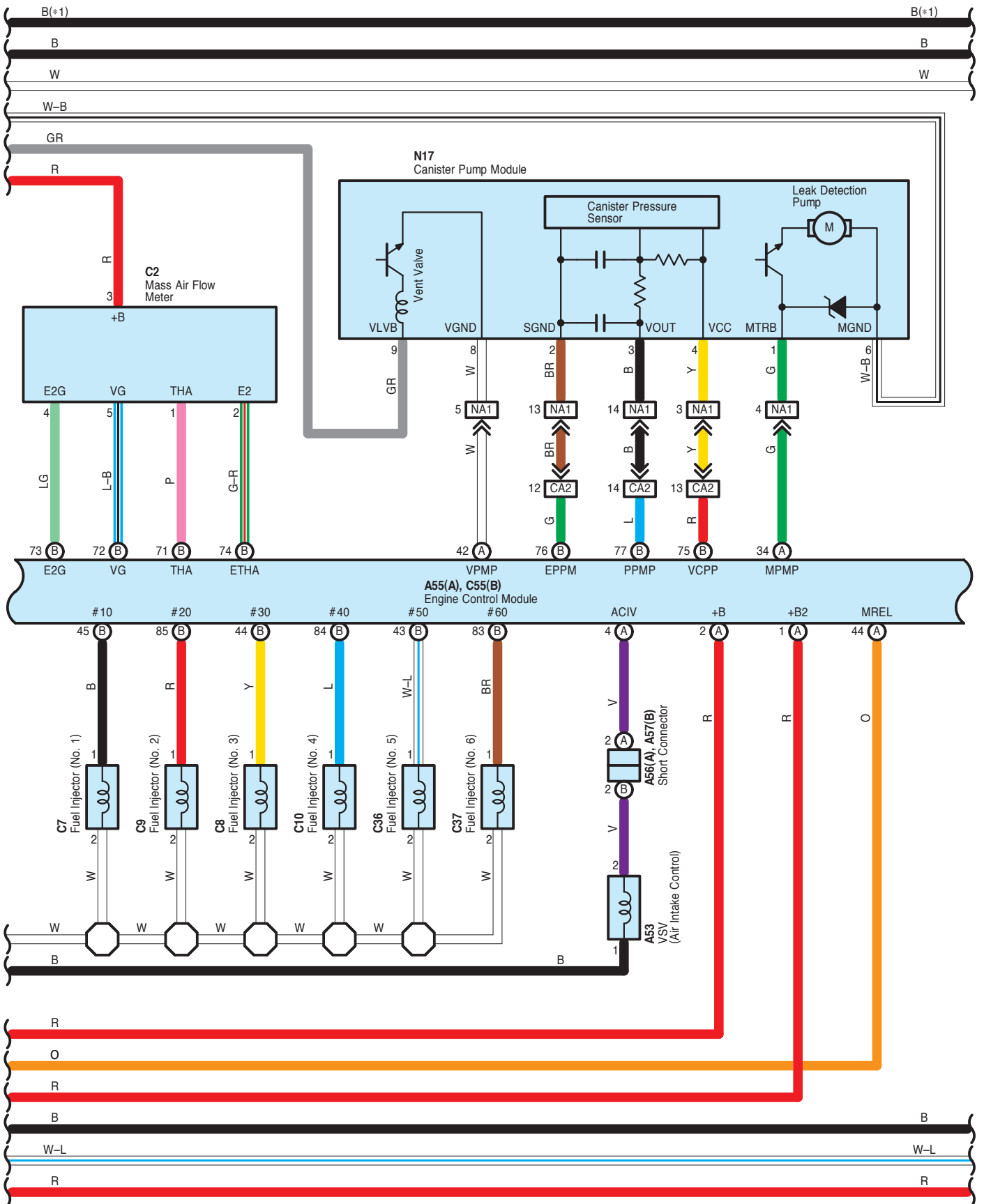

Engine Control <2GR-FE>

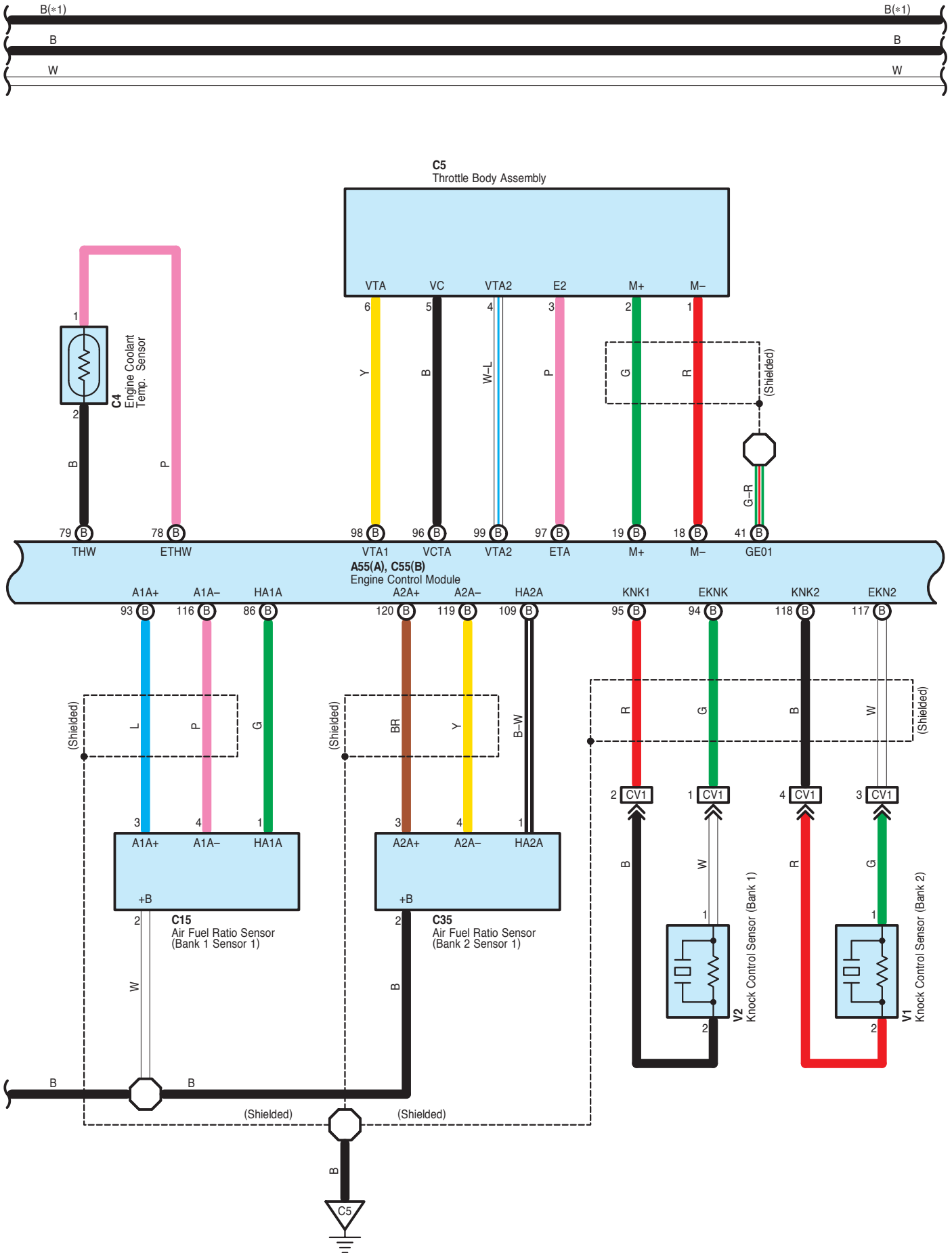

Engine Control <2GR-FE>

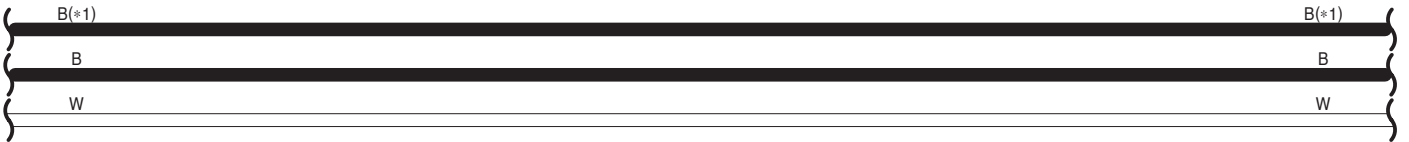

* 1 : w/ Smart Key System

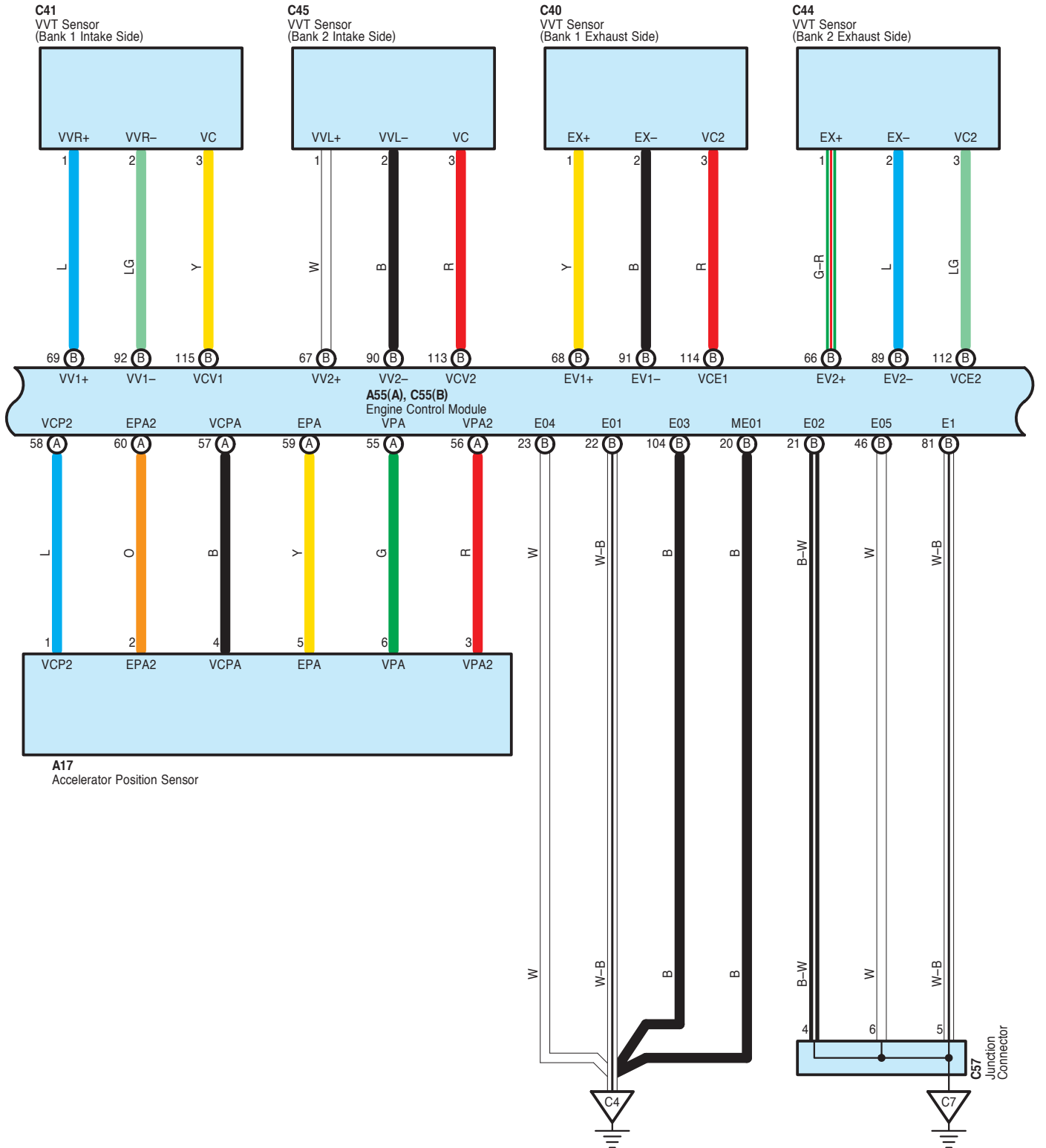

Engine Control <2GR-FE>

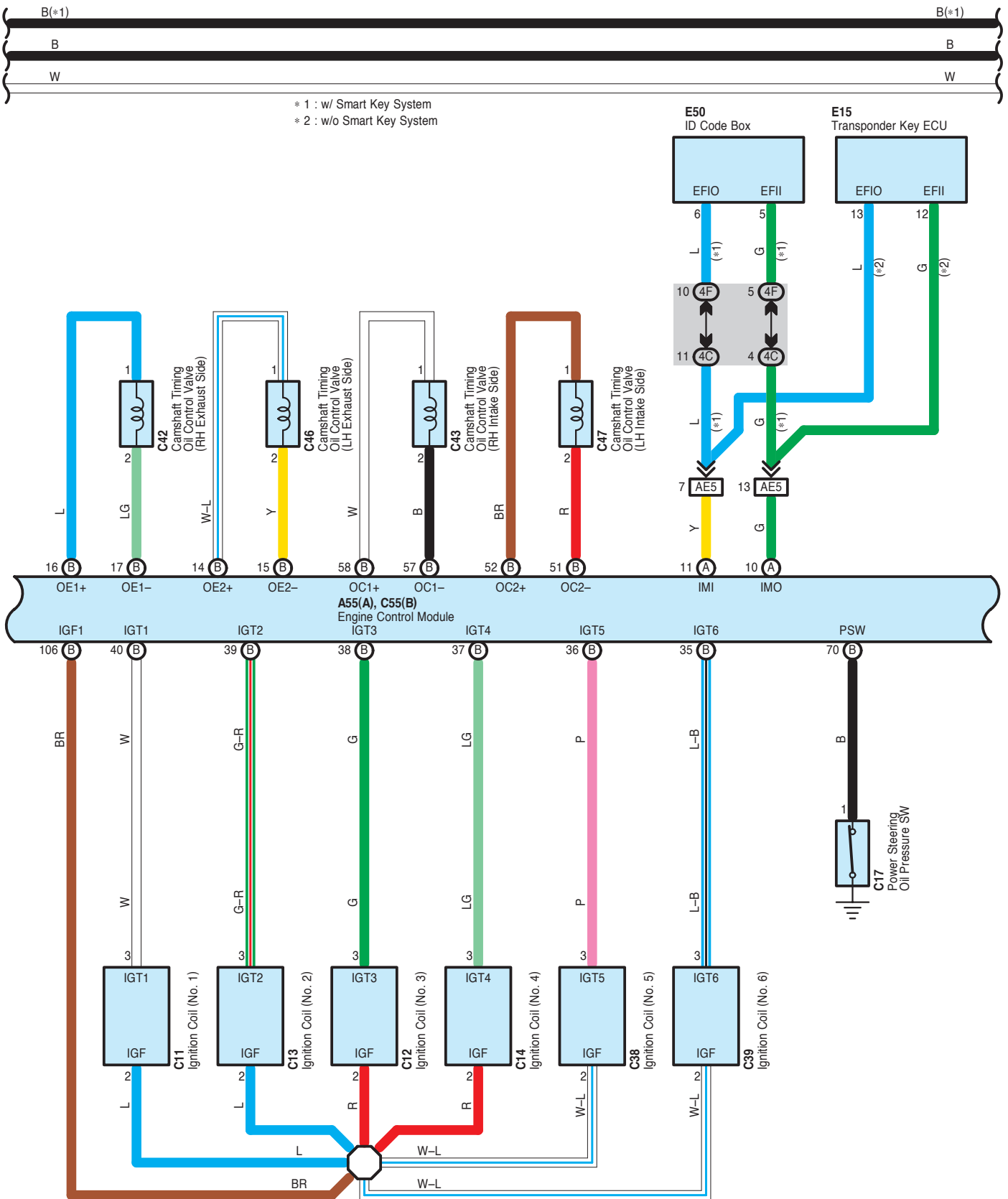

Engine Control <2GR-FE>

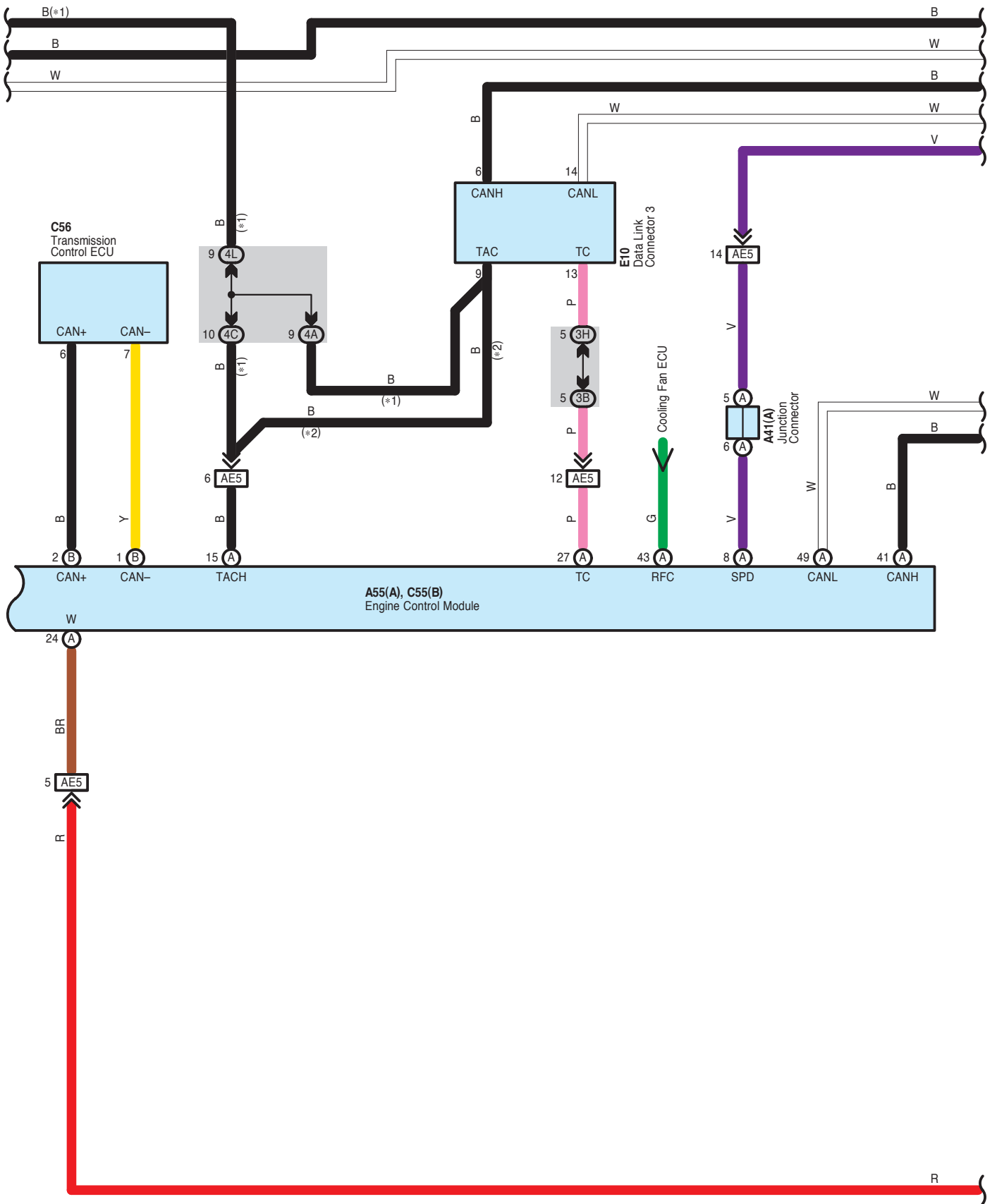

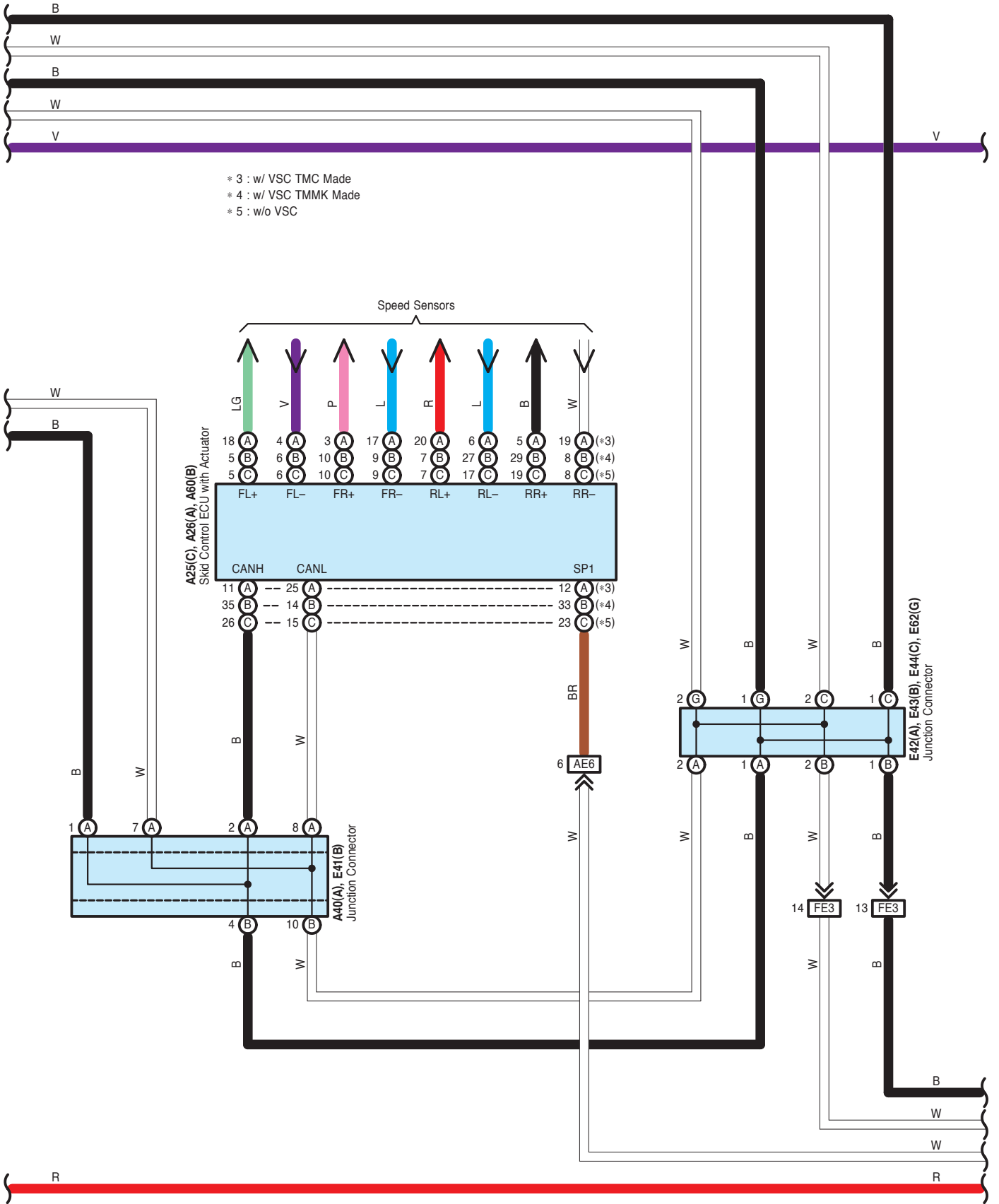

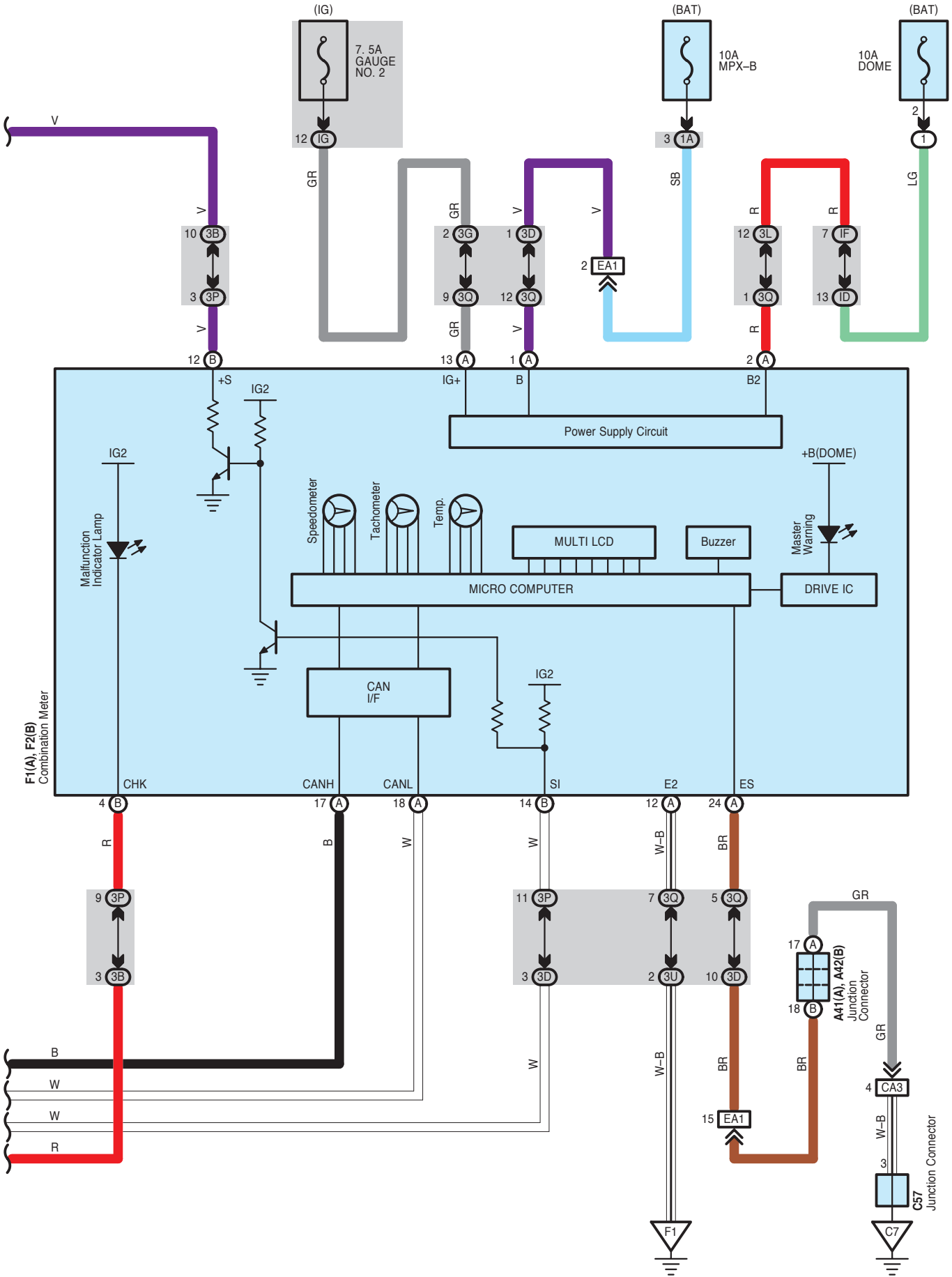

A 17
Black

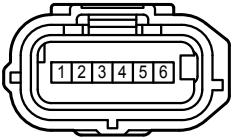

A 19
Blue

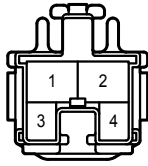

A 25
Black

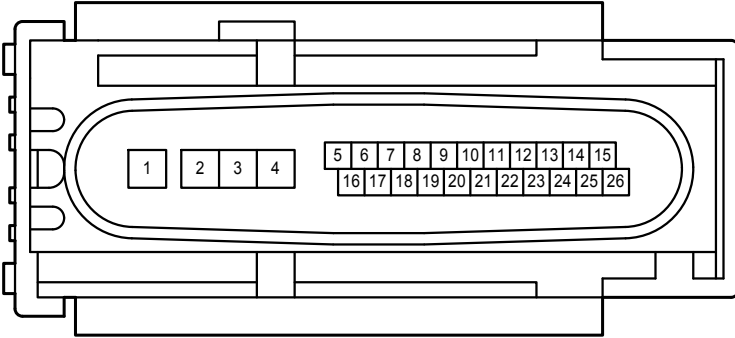

A 26
Black

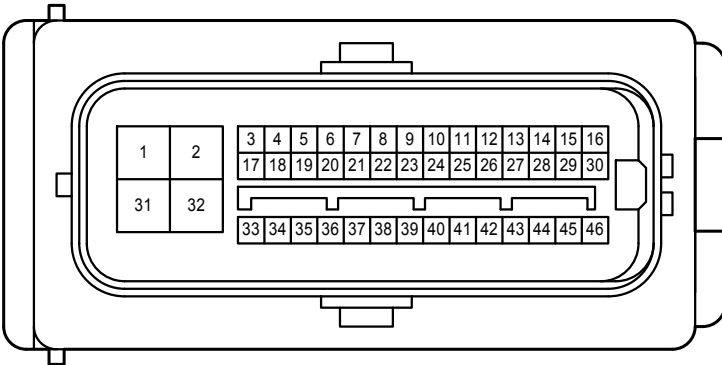

A 40
Blue

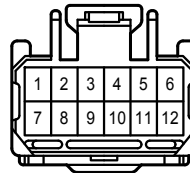

A 41
White

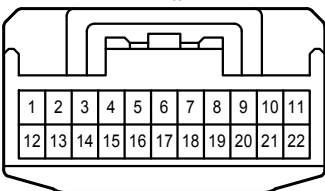

A 42
White

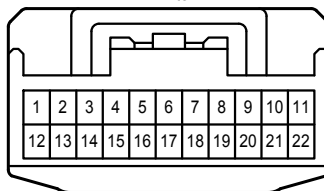

A 43
Gray

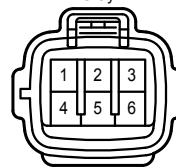

Engine Control <2GR-FE>

A 53
Black

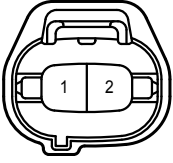

A 55
Black

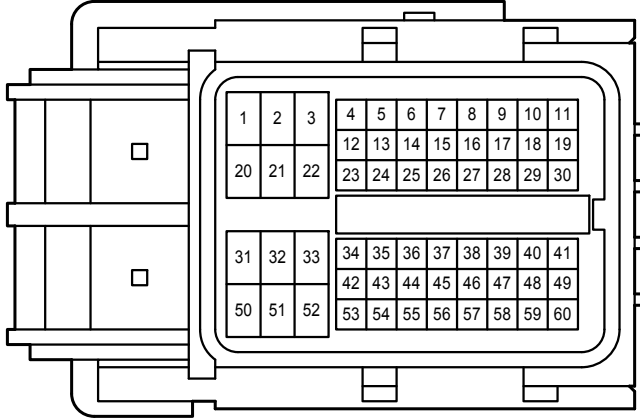

A 56
White

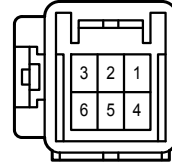

A 57
White

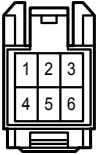

A 58
Black

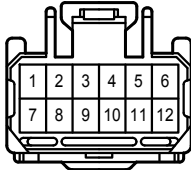

A 60
Black

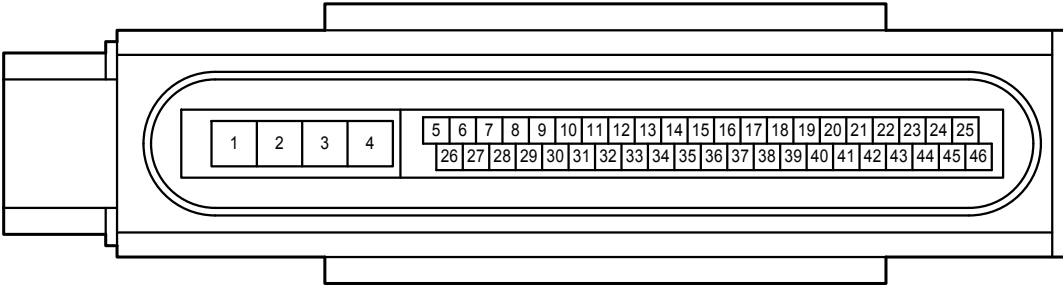

C 1
Gray

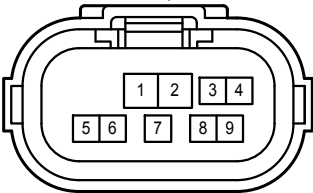

C 2
Black



C 4
Black



C 5
Black

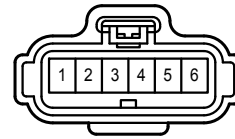

C 6
Black

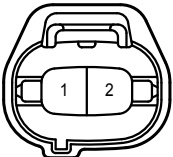

C 7
Gray

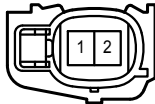

C 8
Gray

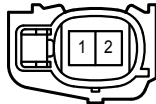

C 9
Gray

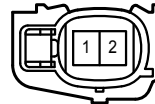

C 10
Gray

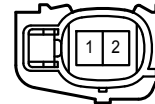

Engine Control <2GR-FE>

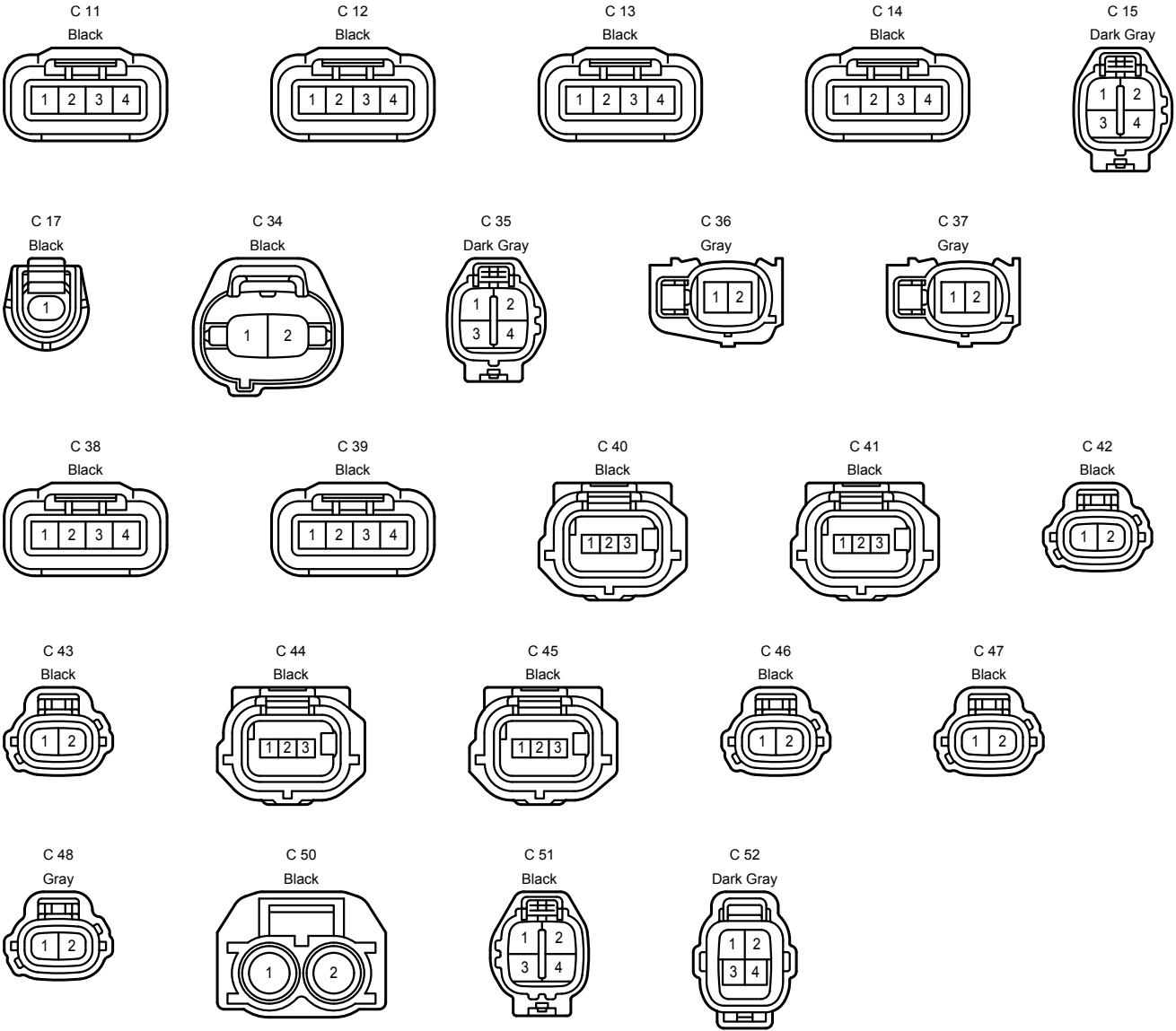

C 55
Black

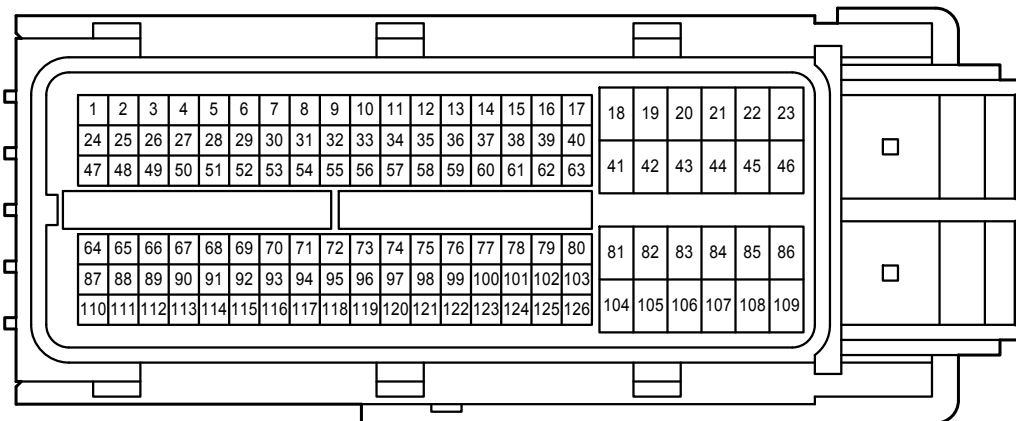

C 56
Black

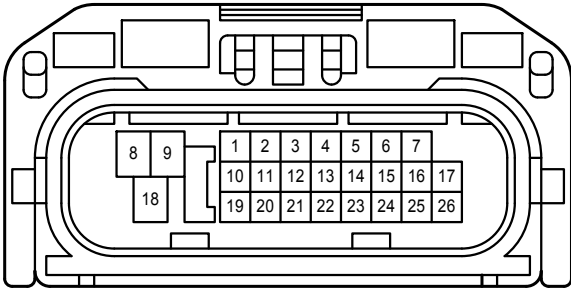

C 57
Gray

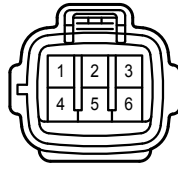

E 6
White

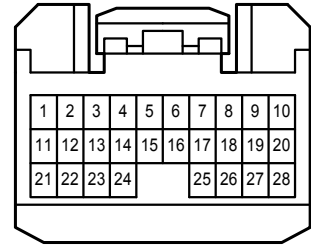

E 7
White

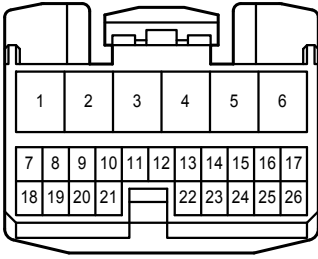

E 8
White

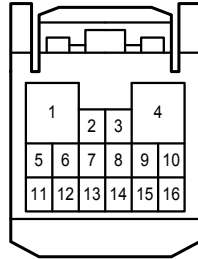

E 9
White

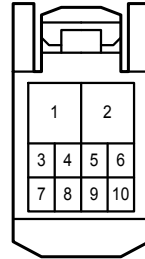

E 10
Black

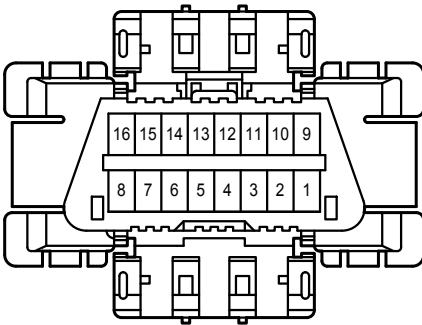

E 15
White

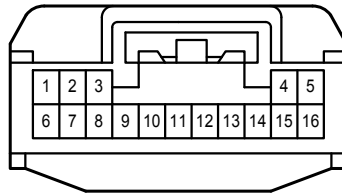

E 23
White

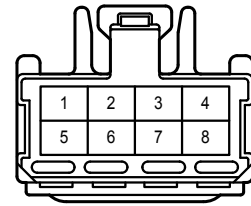

E 40
White

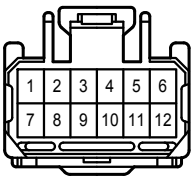

E 41
Blue

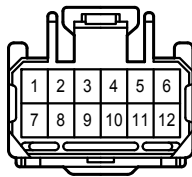

E 42
White

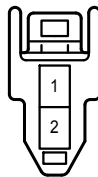

E 43
White

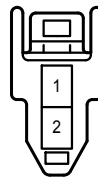

E 44
Black

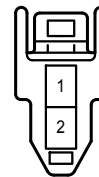

E 50
White

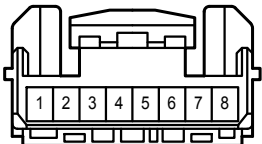

E 62
Gray

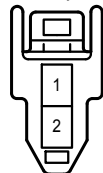

F 1
White

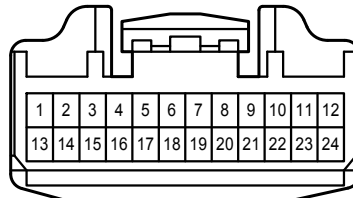

F 2
White

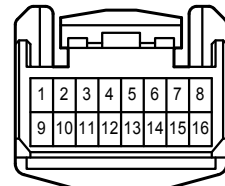

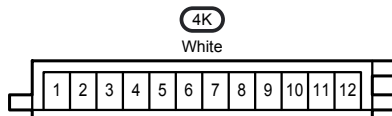
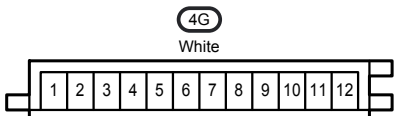
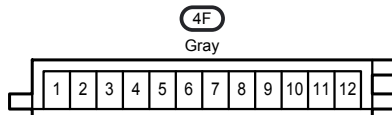
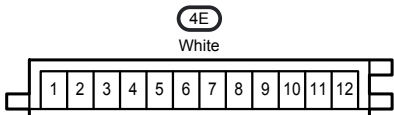
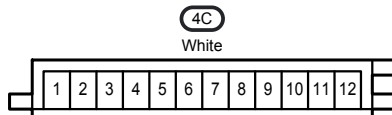
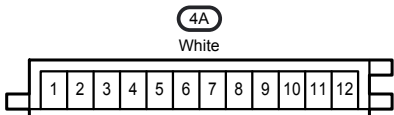
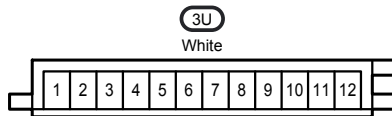
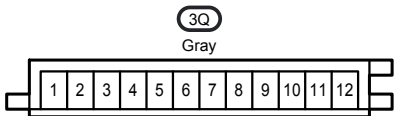
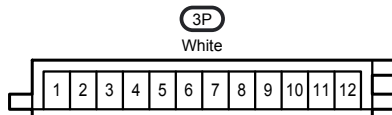
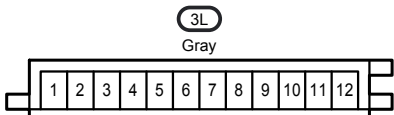
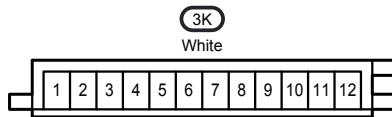
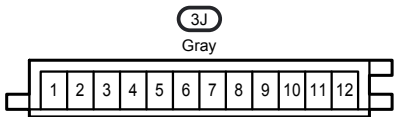
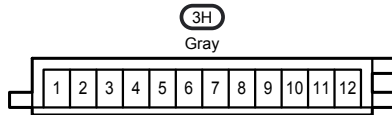
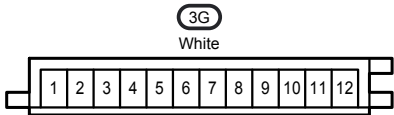
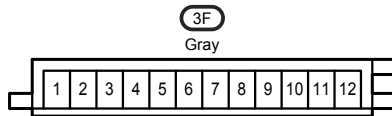
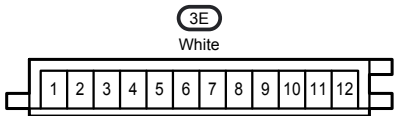
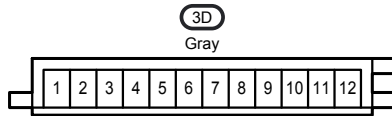
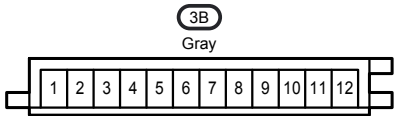
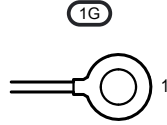
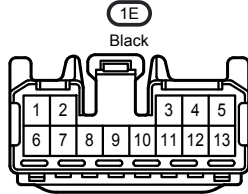
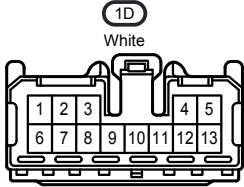
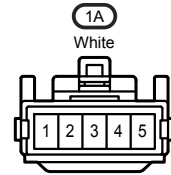
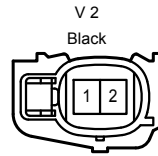
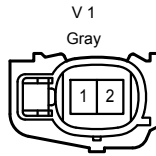
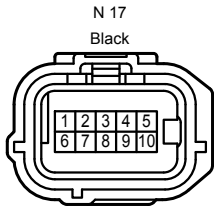
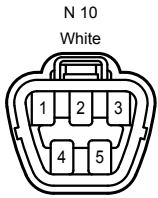

Engine Control <2GR-FE>

4L

Gray

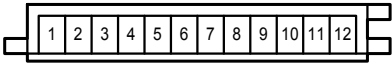

4M

White

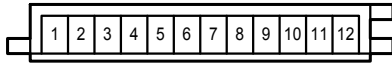

IC

White

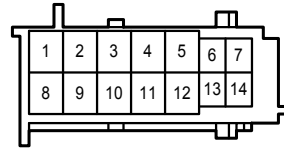

ID

White

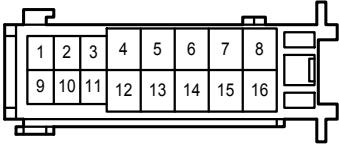

IF

White

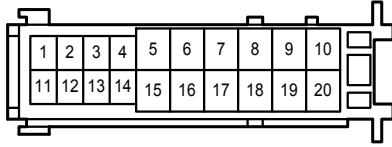

IG

White

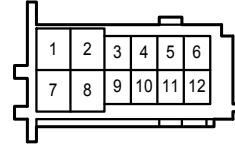

II

White

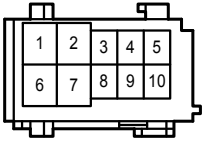

AE5

White

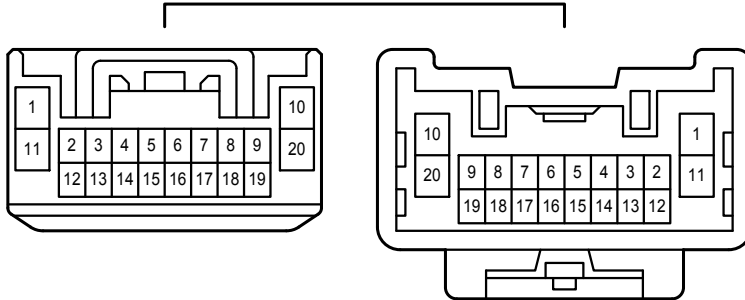

AE6

Gray

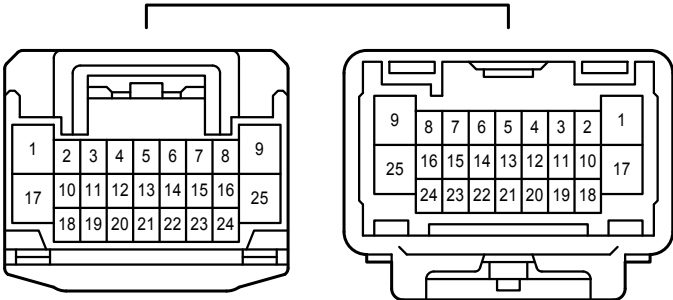

AE7

White

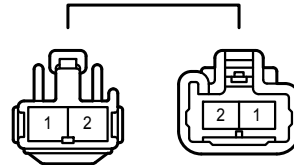

CA1

White

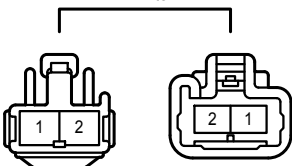

CA2

Black

White

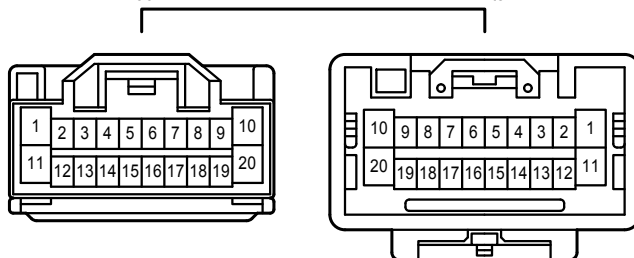

CA3
White

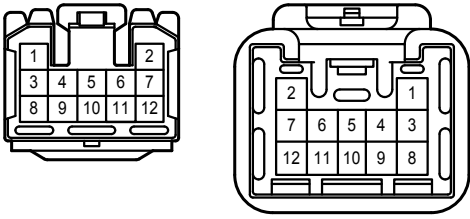

CV1
Gray

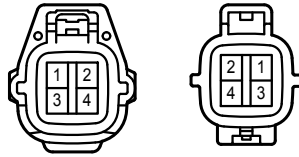

EA1
White

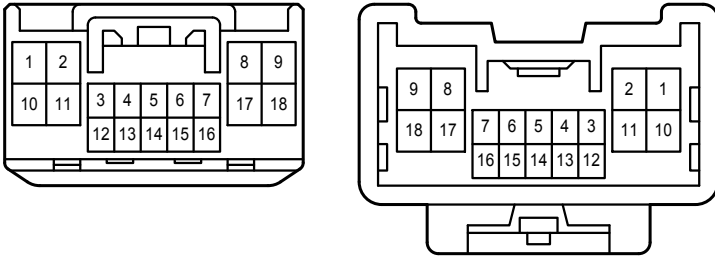

FE3
Gray

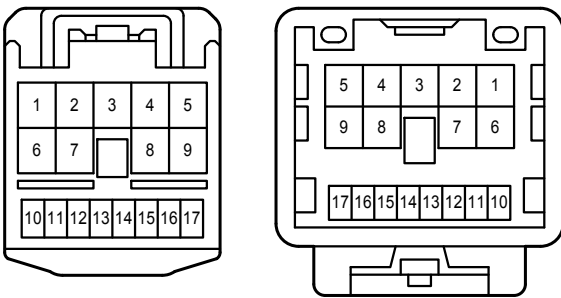

NA1
Black

