

- \* 1 : Shielded
- \* 2 : w/ Trailer Towing
- \* 3 : w/o Trailer Towing

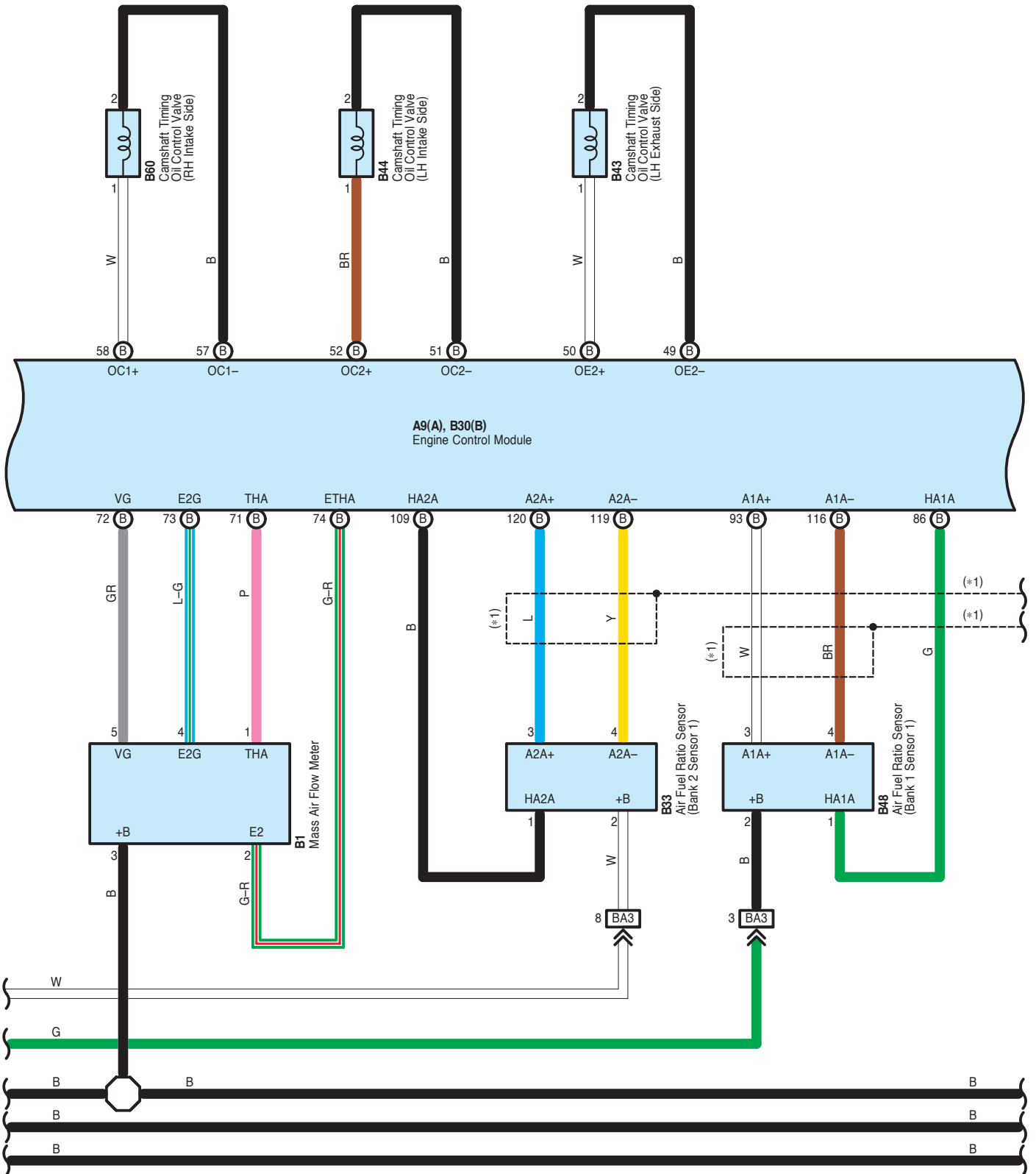

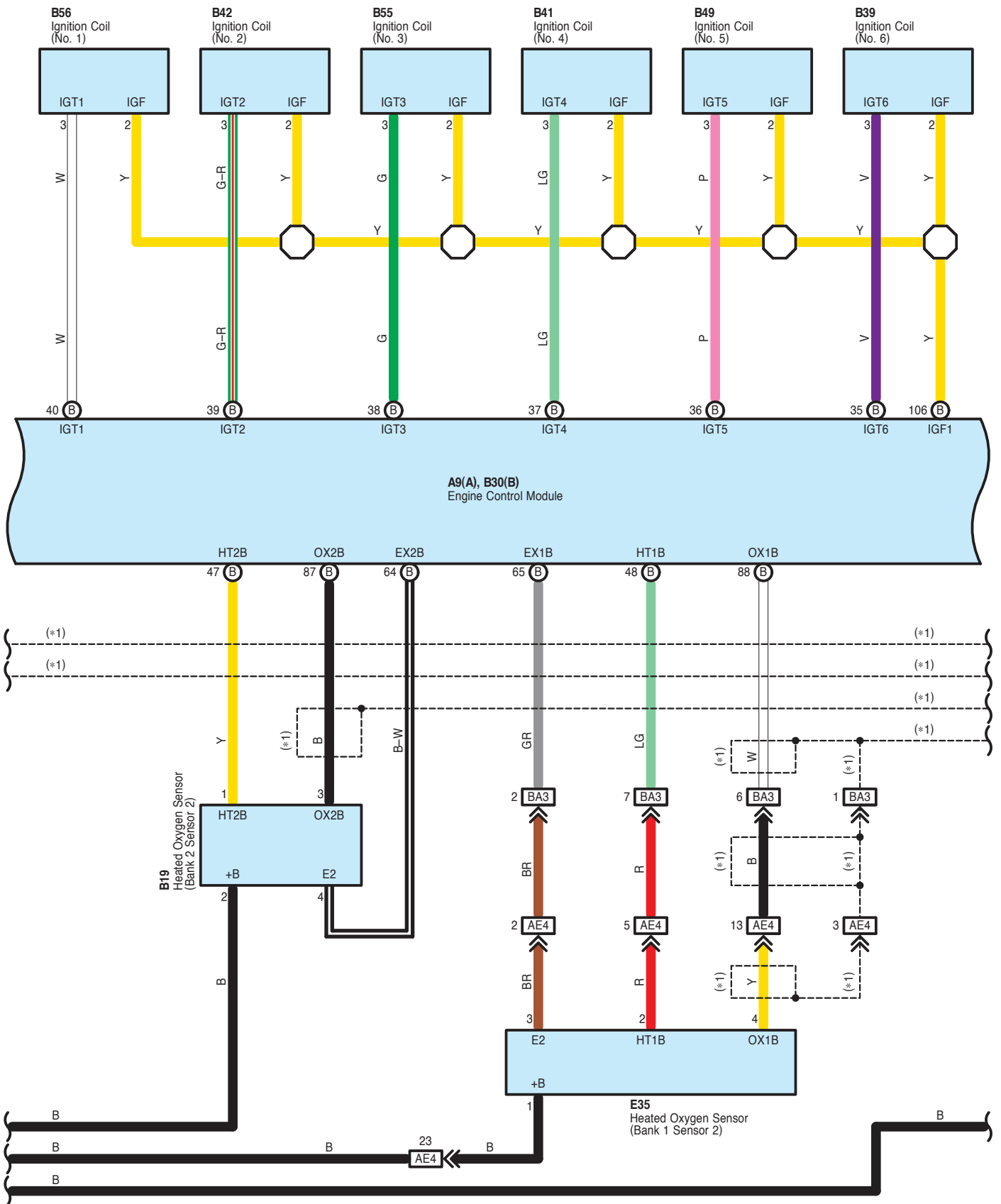

\* 1 : Shielded

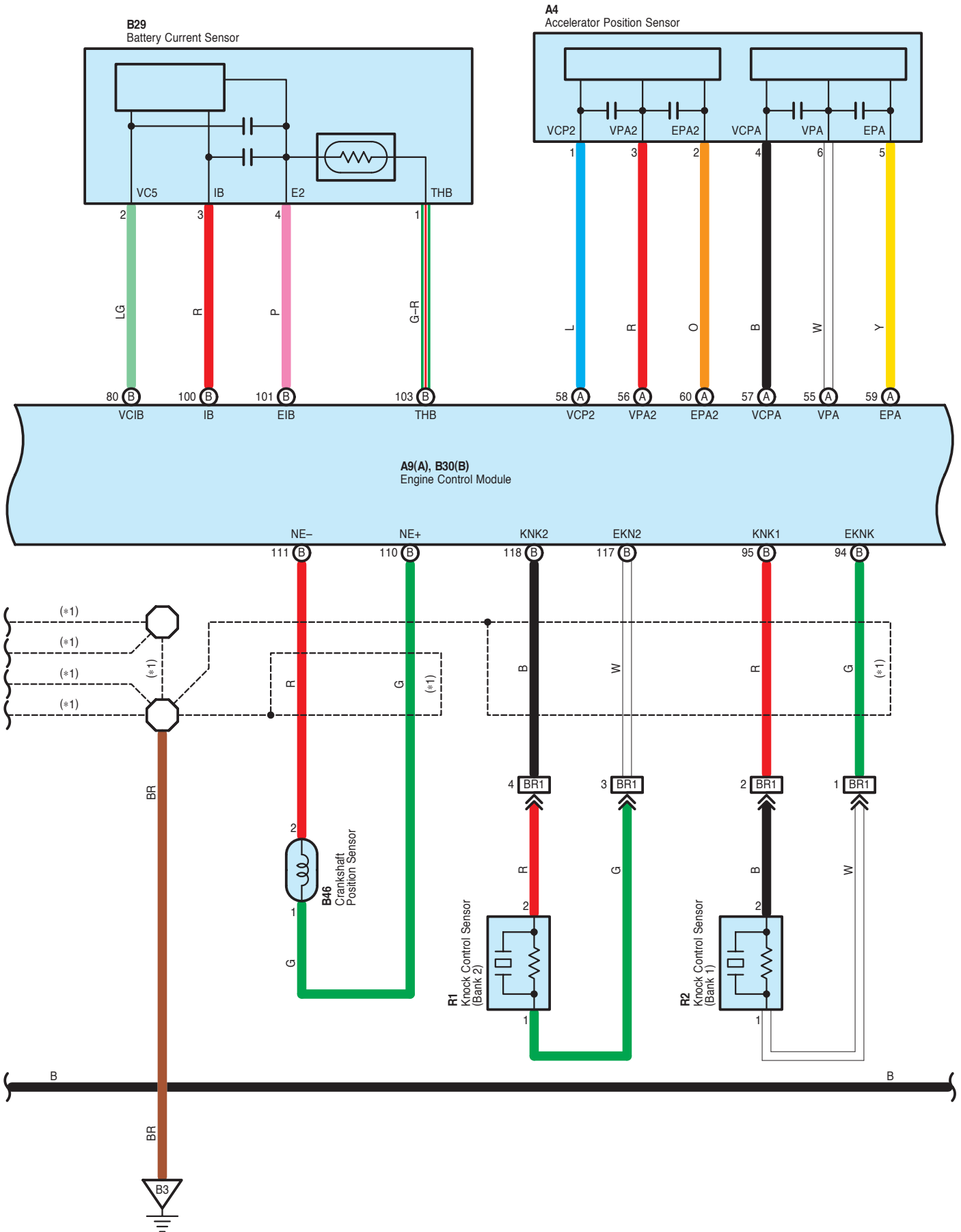

Engine Control <2GR-FE>

- \* 2 : w/ Trailer Towing
- \* 3 : w/o Trailer Towing
- \* 4 : w/ Power Outlet (115V)
- \* 5 : w/o Power Outlet (115V)

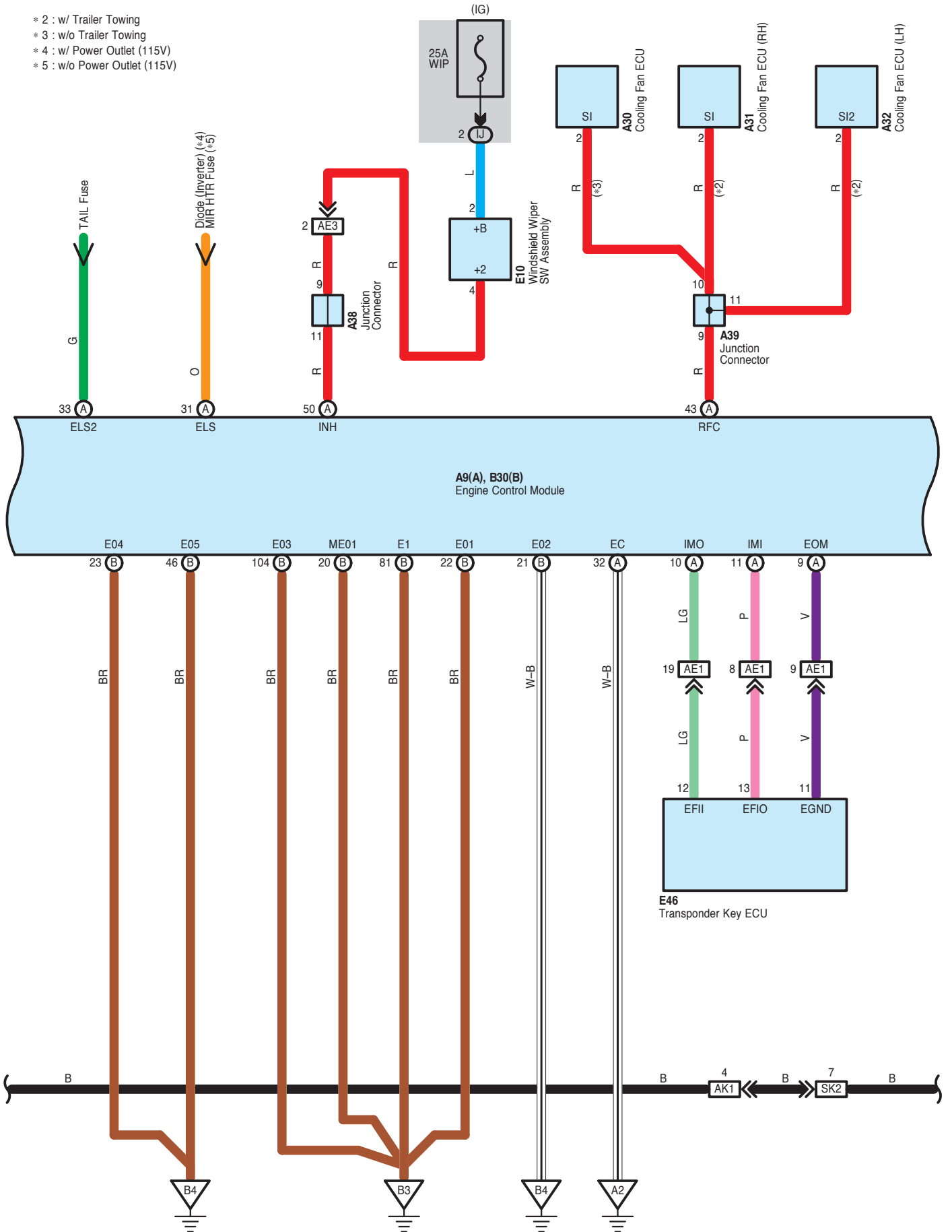

Engine Control <2GR-FE>

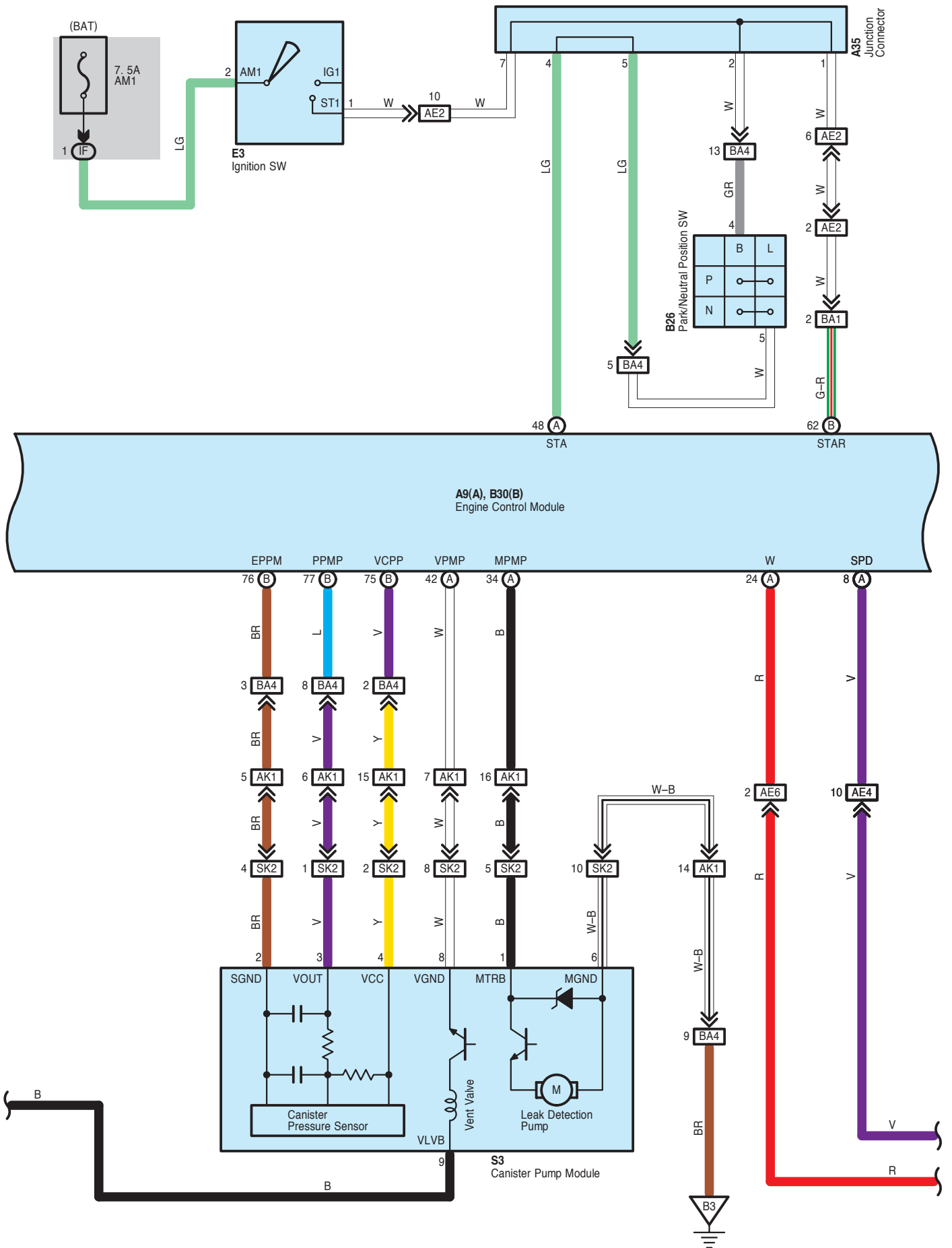







Engine Control <2GR-FE>

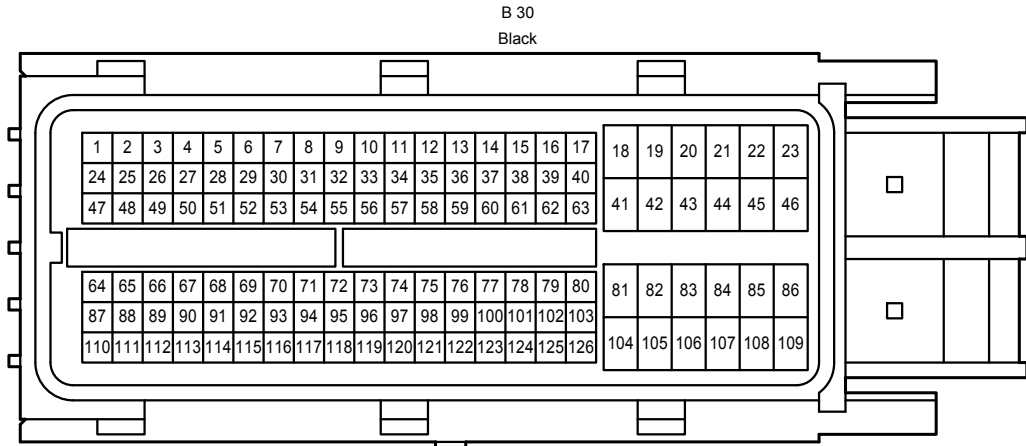
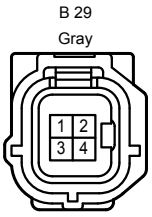

(2GR-FE)

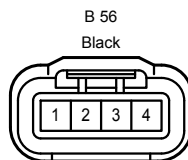
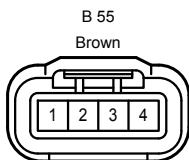
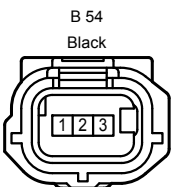
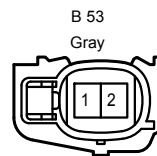
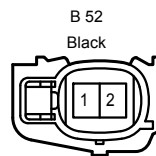
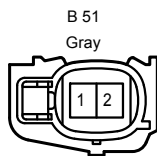
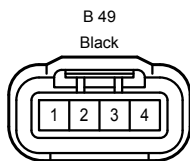
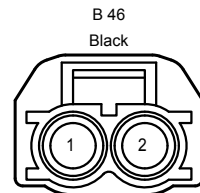
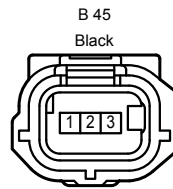
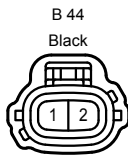
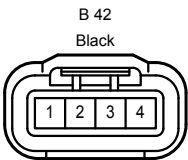
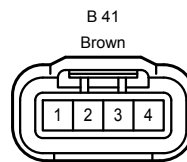
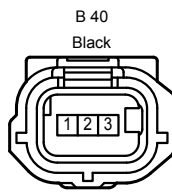
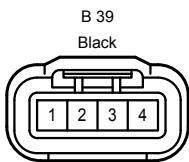
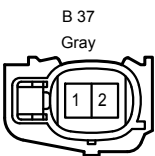
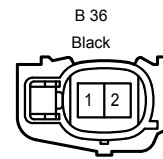
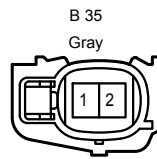
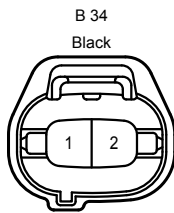
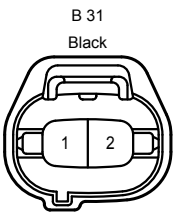

Engine Control <2GR-FE>

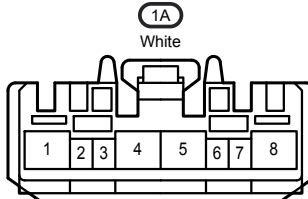
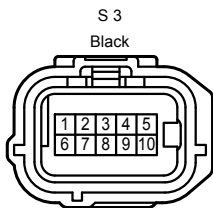
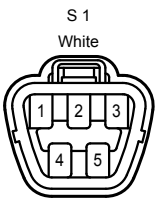
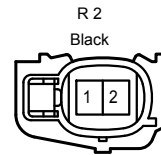
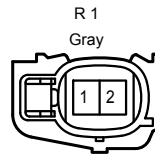
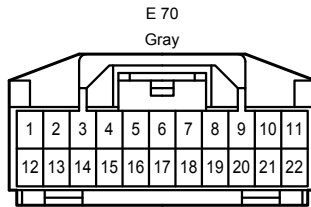
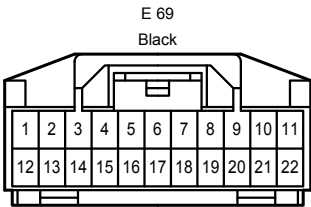
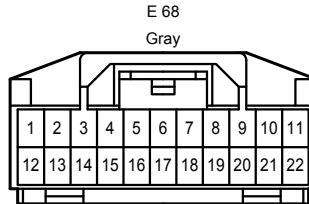
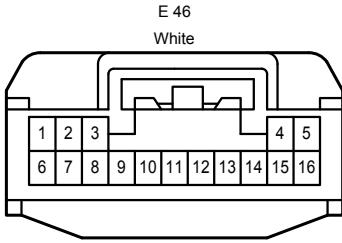
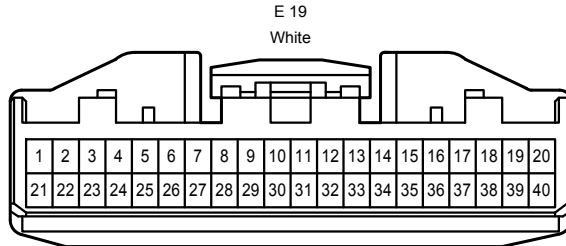
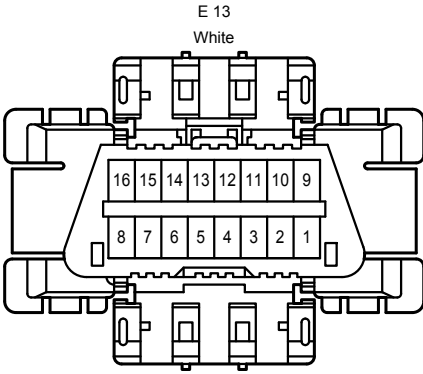
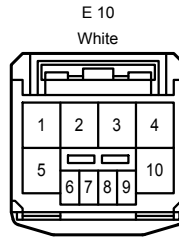
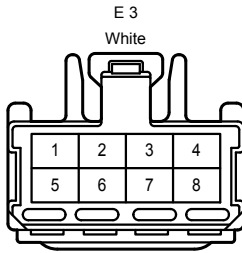
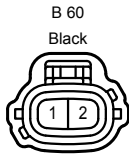
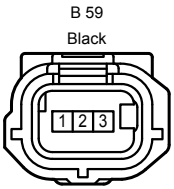

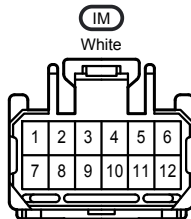
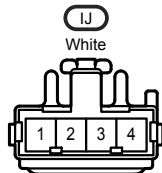
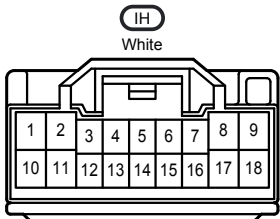
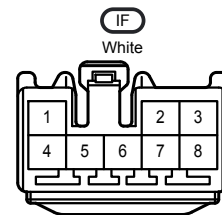
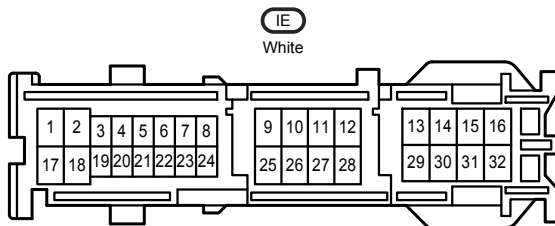
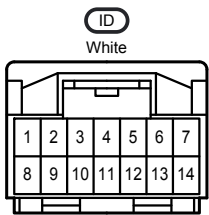
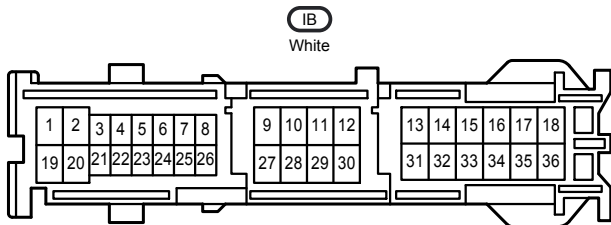
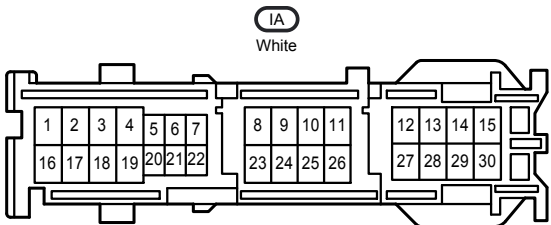
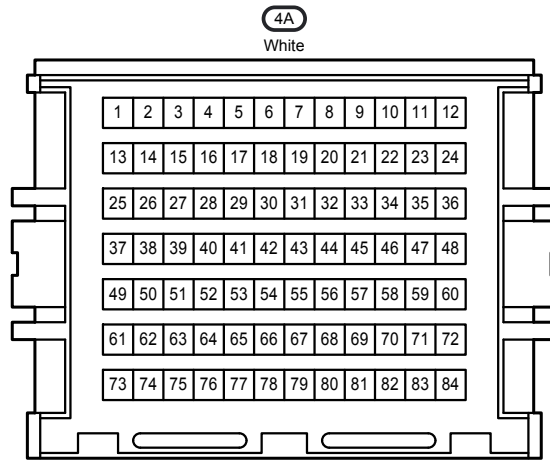
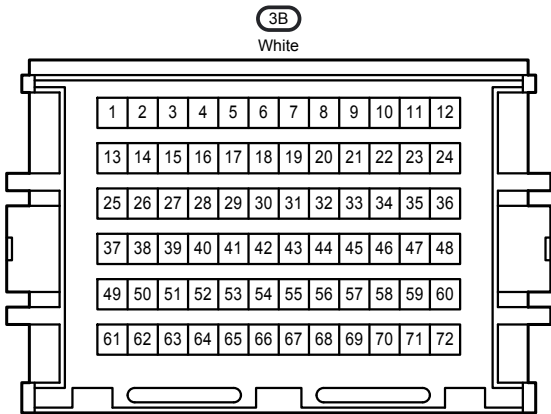
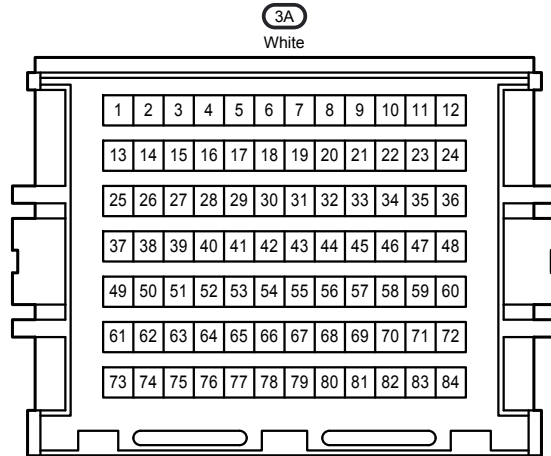
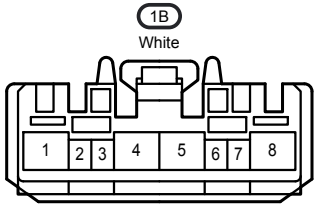

AE1  
White

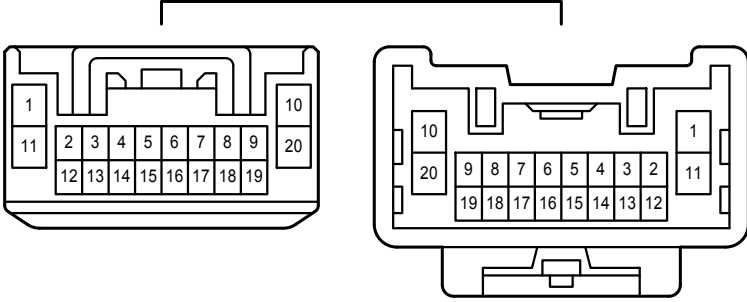

AE2  
White

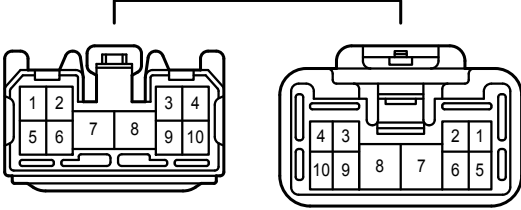

AE3  
Black

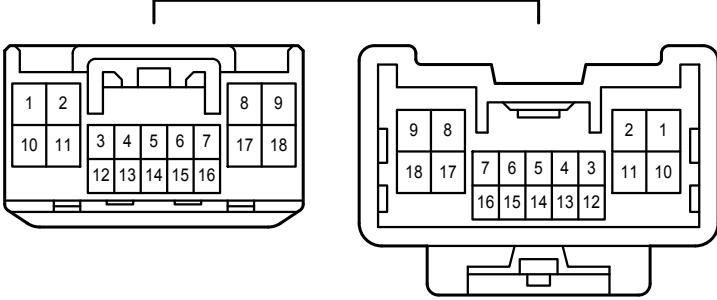

AE4  
Gray

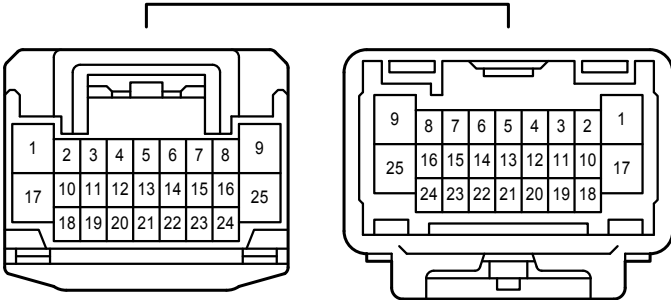

AE6  
White

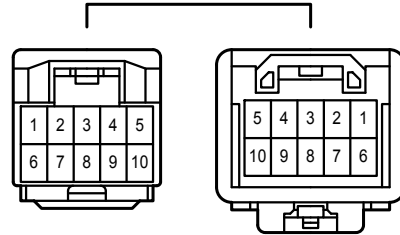

AK1  
White

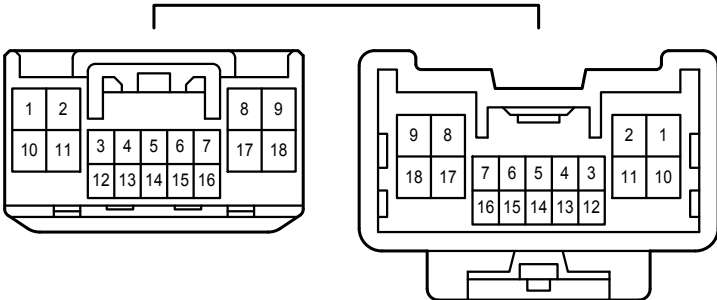

BA1  
White

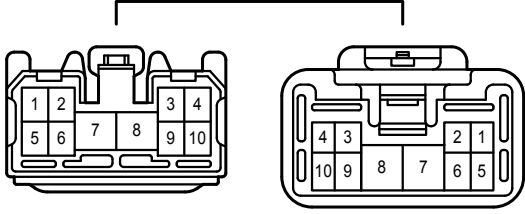

BA3  
White

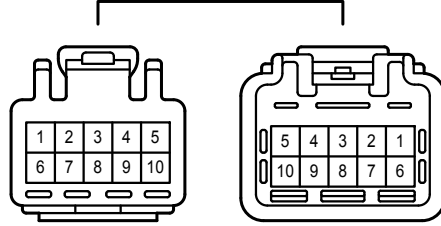

BA4  
Gray

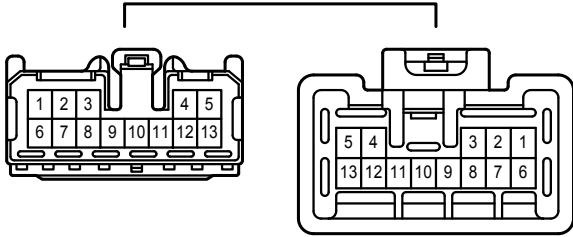

BR1  
Gray

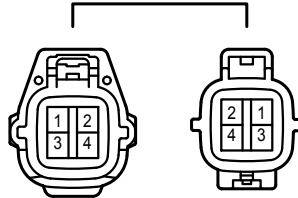

SK1  
White

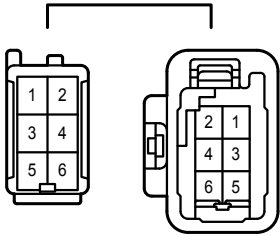

SK2  
Black

